

**MB699VP-B**



miniSAS HD  
SFF-8643 Connector

**MB699VP-B V2**



OCuLink  
SFF-8612 Connector



Cremax Europe GmbH  
Weidenweg 21H  
47059 Duisburg, Germany  
Email: support@icydock.com

Copyright © ICY DOCK International. All Rights Reserved. 6502861 VER 2.0

**1**

Package Contents • Packungsinhalt • Contenu • Contenido del paquete • 包装について • 包装説明 • 包装说明

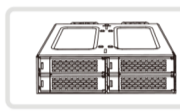

Device



User Manual

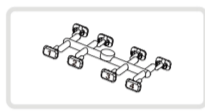

Drive ID Plug



8 x M3\*2.5 Pan Head Screw For Device  
2 x Screw For Spare Parts



16 x M3\*4 Flat Head Screw For 2.5" SSD  
2 x Screw For Spare Parts

⚠ Note: Please use the included screws to secure the device and the drive(s)

**2**

Device Information • Geräteinformationen • Informations dispositif • Información del dispositivo • 本体説明 • 機體説明 • 机体说明

▼ Front View

MB699VP-B / MB699VP-B V2

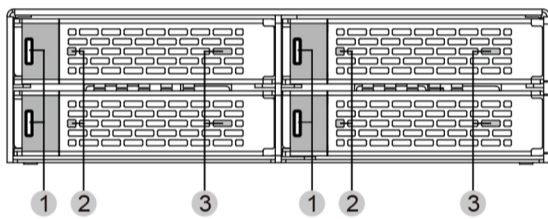

- 1 Drive Tray Ejection Button
- 2 LED Indicator (Power: Solid Green ; Drive Access: Flashing Green)
- 3 Slot For Drive ID Plug

▼ Rear View

MB699VP-B

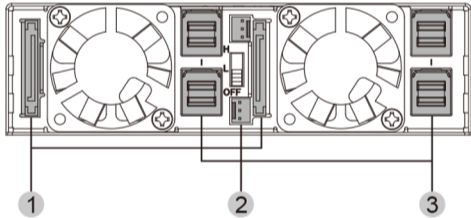

MB699VP-B V2

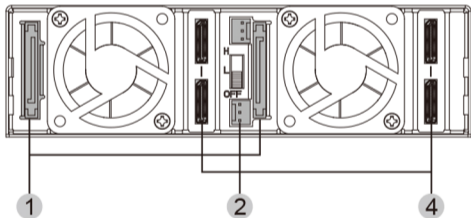

- 1 15 Pin Power Port
- 2 3 Pin Fan Header Port
- 3 miniSAS HD Connector Port
- 4 OCuLink Connector Port

**3**

Installation Guide • Installationsanleitung • Guide d'Installation • Guía de instalación • 製品の組み込み手順について • 操作步驟 • 操作步驟

1



3

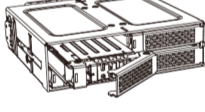

2

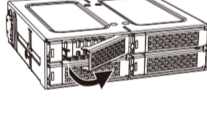

4



The tray accommodates U.2 NVMe drives up to 15mm in height. Flip both tray and drive to the bottom side to insert the drive.

5

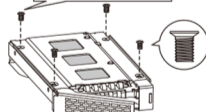

Align the four screw holes to the drive and use the included M3\*4 screws to install.

6

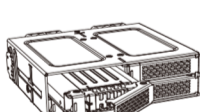

Insert the drive with tray back into the device to complete installation.

(Optional)

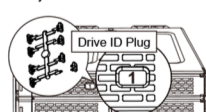

Insert the drive ID plug into the slot, according to your preference.

**4**

Device Installation • Installation eines Gerätes • Installation du dispositif • Instalación del dispositivo de • デバイス取付手順 • 装置安裝步驟 • 设备安装步骤

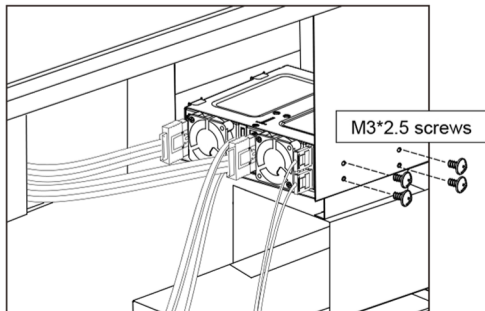

- 1. Insert the device into external 5.25" bay and use the included M3\*2.5 screws to secure the device
- 2. Connect miniSAS HD and OCuLink cables to the device to finish installation



For the warranty information, please visit [www.icydock.com/warranty.php](http://www.icydock.com/warranty.php)