

Scan the QR code for more product information

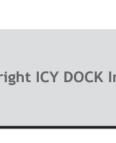

Cremax Europe GmbH
Weidenweg 21H
47059 Duisburg, Germany
Email: support@icydock.com

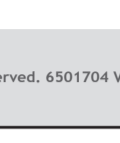

Copyright ICY DOCK International. All Rights Reserved. 6501704 VER 5.0

1

Package Contents • Packungsinhalt • Contenu • Contenido del paquete
• 包装について • 包装説明 • 包装说明

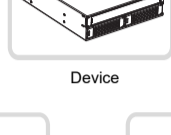

Device



User Manual

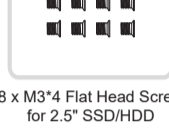

8 x M3*4 Flat Head Screw for 2.5" SSD/HDD

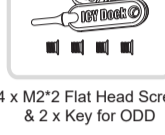

4 x M2*2 Flat Head Screw & 2 x Key for ODD



10 x M3*2.5 Pan Head Screw for Device (2 x Screw for Spare Parts)

2

Device Information • Geräteinformationen • Informations dispositif
• Información del dispositivo • 本体説明 • 機體説明 • 机体说明

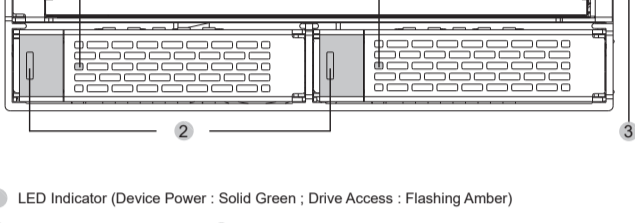

- 1 LED Indicator (Device Power : Solid Green ; Drive Access : Flashing Amber)
- 2 Drive Tray Ejection Button
- 3 Slim ODD Ejection Hole (Insert the key to open the latch)

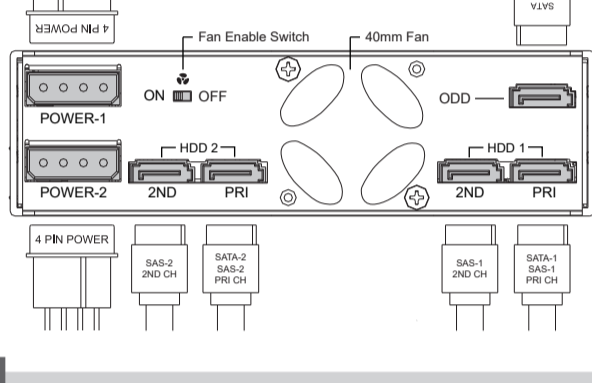

3

Installation Guide • Installationsanleitung • Guide d'Installation • Guía de instalación
• 製品の組み込み手順について • 操作步驟 • 操作步驟

2-1



2-2

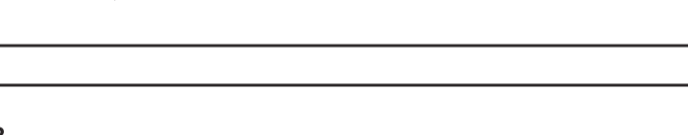

2-3

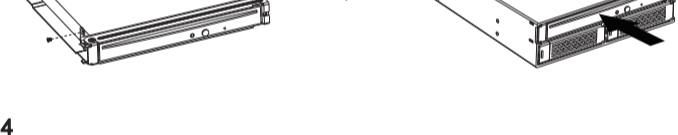

2-4



2-5

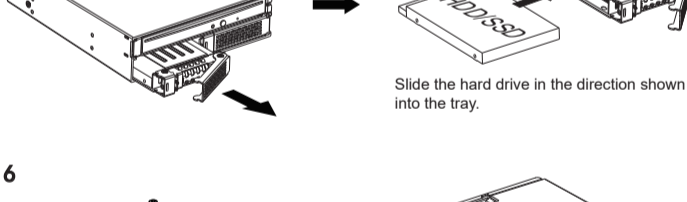

Slide the hard drive in the direction shown into the tray.

2-6



2-7

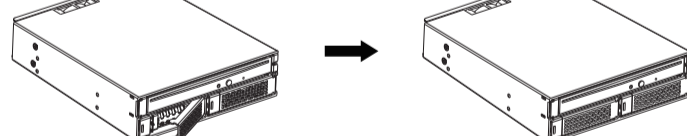

2-8

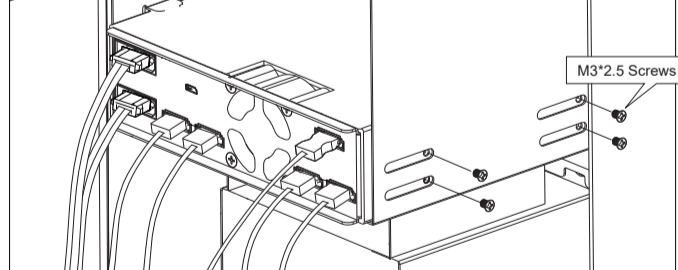

Connect both 4 Pin power cables and SATA/SAS cables to the device.

Note: The host end must support SAS interface in order use SAS hard drives / SSDs. Please use primary port connector when using SATA hard drives / SSDs.

